

Article number: 439600190

Description: Rota-fix shaft-hub connection FS190x250

Note: Self centering - very high torque.

Measures

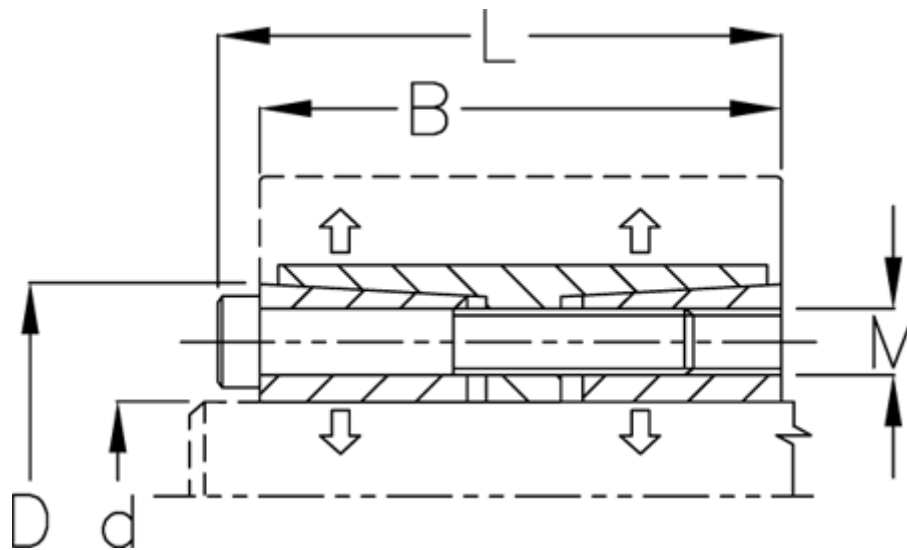

B mm	= 105
d H8 mm	= 190
D mm	= 250
Fit tolerance	= Aksel h8, Nav H8
F kN torque	= 847.0
L mm	= 119
M mm	= M14
P N/mm ² surface pressure on shaft/hub	= 118

Surface roughness	= R? ? 3.2 μm
T N m torque	= 80500
Ts N m bolt tightening torque	= 230.0